



Revision: 00

Introduction to SVE

Non-Confidential
Copyright © 2021 Arm Limited (or its affiliates).
All rights reserved.

Issue 00
102476_0001

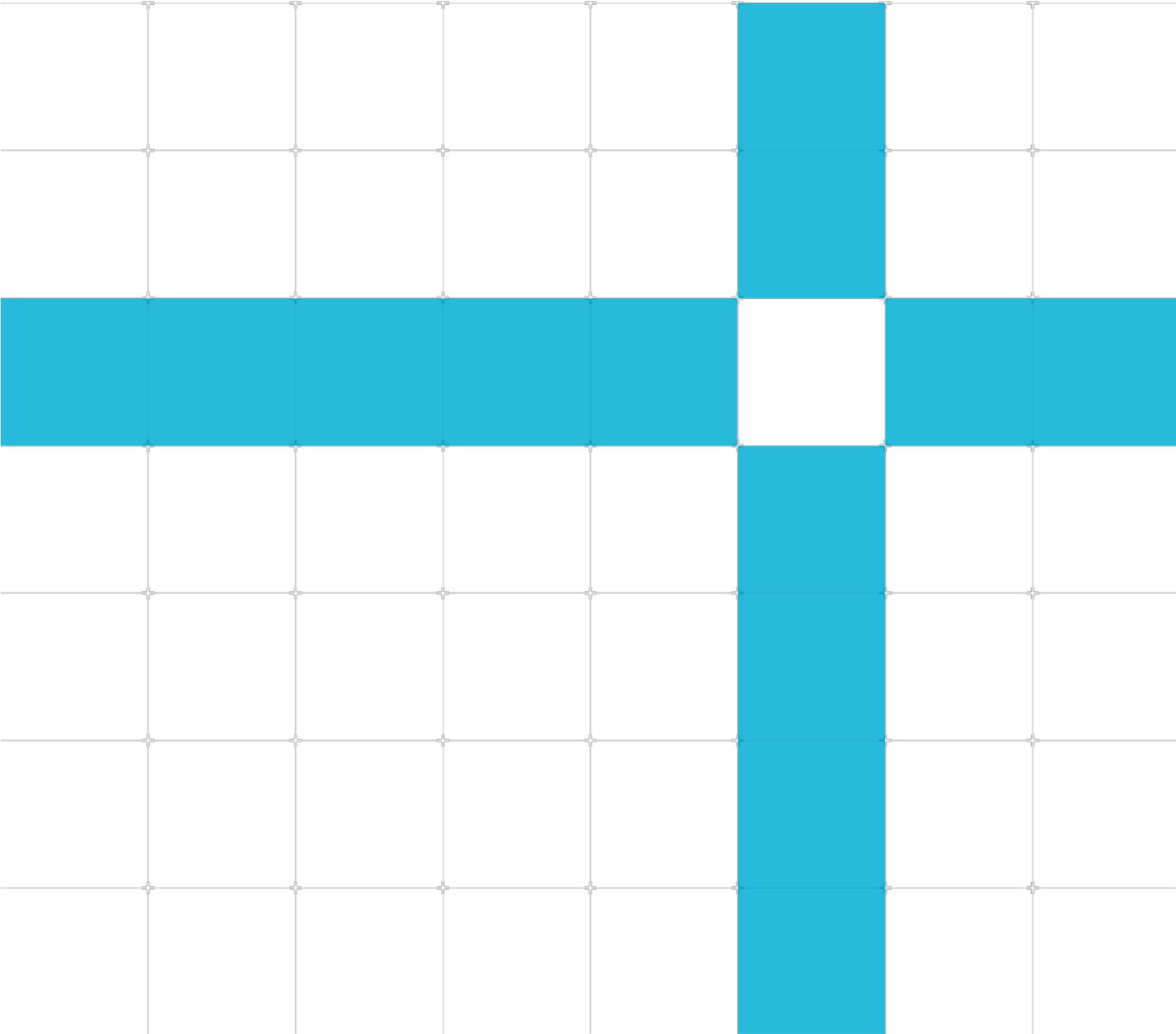

Introduction to SVE

Copyright © 2021 Arm Limited (or its affiliates). All rights reserved.

Release information

Document history

Issue	Date	Confidentiality	Change
0001_00	19 March 2021	Non Confidential	First release.

Non-Confidential Proprietary Notice

This document is protected by copyright and other related rights and the practice or implementation of the information contained in this document may be protected by one or more patents or pending patent applications. No part of this document may be reproduced in any form by any means without the express prior written permission of Arm. No license, express or implied, by estoppel or otherwise to any intellectual property rights is granted by this document unless specifically stated.

Your access to the information in this document is conditional upon your acceptance that you will not use or permit others to use the information for the purposes of determining whether implementations infringe any third party patents.

THIS DOCUMENT IS PROVIDED "AS IS". ARM PROVIDES NO REPRESENTATIONS AND NO WARRANTIES, EXPRESS, IMPLIED OR STATUTORY, INCLUDING, WITHOUT LIMITATION, THE IMPLIED WARRANTIES OF MERCHANTABILITY, SATISFACTORY QUALITY, NON-INFRINGEMENT OR FITNESS FOR A PARTICULAR PURPOSE WITH RESPECT TO THE DOCUMENT. For the avoidance of doubt, Arm makes no representation with respect to, and has undertaken no analysis to identify or understand the scope and content of, patents, copyrights, trade secrets, or other rights.

This document may include technical inaccuracies or typographical errors.

TO THE EXTENT NOT PROHIBITED BY LAW, IN NO EVENT WILL ARM BE LIABLE FOR ANY DAMAGES, INCLUDING WITHOUT LIMITATION ANY DIRECT, INDIRECT, SPECIAL, INCIDENTAL, PUNITIVE, OR CONSEQUENTIAL DAMAGES, HOWEVER CAUSED AND REGARDLESS OF THE THEORY OF LIABILITY, ARISING OUT OF ANY USE OF THIS DOCUMENT, EVEN IF ARM HAS BEEN ADVISED OF THE POSSIBILITY OF SUCH DAMAGES.

This document consists solely of commercial items. You shall be responsible for ensuring that any use, duplication or disclosure of this document complies fully with any relevant export laws and regulations to assure that this document or any portion thereof is not exported, directly or indirectly, in violation of such export laws. Use of the word "partner" in reference to Arm's customers is not intended to create or refer to any partnership relationship with any other company. Arm may make changes to this document at any time and without notice.

If any of the provisions contained in these terms conflict with any of the provisions of any click through or signed written agreement covering this document with Arm, then the click through or signed written agreement prevails over and supersedes the conflicting provisions of these terms. This document may be translated into other languages for convenience, and you agree that if there is any conflict between the English version of this document and any translation, the terms of the English version of the Agreement shall prevail.

The Arm corporate logo and words marked with ® or ™ are registered trademarks or trademarks of Arm Limited (or its affiliates) in the US and/or elsewhere. All rights reserved. Other brands and names mentioned in this

document may be the trademarks of their respective owners. Please follow Arm's trademark usage guidelines at <http://www.arm.com/company/policies/trademarks>.

Copyright © 2021 Arm Limited (or its affiliates). All rights reserved.

Arm Limited. Company 02557590 registered in England.

110 Fulbourn Road, Cambridge, England CB1 9NJ.

(LES-PRE-20349)

Confidentiality Status

This document is Non-Confidential. The right to use, copy and disclose this document may be subject to license restrictions in accordance with the terms of the agreement entered into by Arm and the party that Arm delivered this document to.

Unrestricted Access is an Arm internal classification.

Product Status

The information in this document is Final, that is for a developer product.

Web Address

developer.arm.com

Progressive terminology commitment

Arm values inclusive communities. Arm recognizes that we and our industry have used terms that can be offensive. Arm strives to lead the industry and create change.

We believe that this document contains no offensive terms. If you find offensive terms in this document, please email terms@arm.com.

Contents

1 Introduction	6
1.1 Product revision status	6
1.2 Intended audience.....	6
1.3 Conventions.....	6
1.3.1 Glossary	6
1.3.2 Typographical conventions.....	7
1.4 Feedback.....	8
1.4.1 Feedback on this product	8
1.4.2 Feedback on content	8
2 Overview.....	9
2.1 Before you begin.....	10
3 Introducing SVE	11
4 SVE architecture fundamentals	12
4.1 Scalable vector registers $z0-z31$	12
4.2 Scalable predicate registers $P0-P15$	13
4.3 Configurable vector length.....	13
4.4 SVE assembly syntax.....	14
4.5 SVE architecture features.....	15
5 Programming with SVE	20
5.1 Software and libraries support.....	20
5.2 How to program for SVE.....	20
5.2.1 Write assembly	20
5.2.2 Use SVE instruction functions (intrinsics).....	21
5.2.3 Auto-vectorization.....	22
5.2.4 Use optimized libraries.....	22
5.3 How to run an SVE application.....	23
6 Check your knowledge	24
7 Related information	25

Appendix A Revisions..... 26

1 Introduction

1.1 Product revision status

The r_{xy} identifier indicates the revision status of the product described in this book, for example, r1p2, where:

r_x

Identifies the major revision of the product, for example, r1.

p_y

Identifies the minor revision or modification status of the product, for example, p2.

1.2 Intended audience

This guide is intended for developers who want to learn about the Scalable Vector Extension (SVE).

1.3 Conventions







The following subsections describe conventions used in Arm documents.

1.3.1 Glossary

The Arm Glossary is a list of terms used in Arm documentation, together with definitions for those terms. The Arm Glossary does not contain terms that are industry standard unless the Arm meaning differs from the generally accepted meaning.

See the Arm Glossary for more information: <https://developer.arm.com/glossary>.

1.3.2 Typographical conventions

Convention	Use
<i>italic</i>	Introduces citations.
bold	Highlights interface elements, such as menu names. Denotes signal names. Also used for terms in descriptive lists, where appropriate.
monospace	Denotes text that you can enter at the keyboard, such as commands, file and program names, and source code.
monospace bold	Denotes language keywords when used outside example code.
monospace <u>underline</u>	Denotes a permitted abbreviation for a command or option. You can enter the underlined text instead of the full command or option name.
<and>	Encloses replaceable terms for assembler syntax where they appear in code or code fragments. For example: <pre>MRC p15, 0, <Rd>, <CRn>, <CRm>, <Opcode_2></pre>
SMALL CAPITALS	Used in body text for a few terms that have specific technical meanings, that are defined in the Arm® Glossary. For example, IMPLEMENTATION DEFINED, IMPLEMENTATION SPECIFIC, UNKNOWN, and UNPREDICTABLE.
 Caution	This represents a recommendation which, if not followed, might lead to system failure or damage.
 Warning	This represents a requirement for the system that, if not followed, might result in system failure or damage.
 Danger	This represents a requirement for the system that, if not followed, will result in system failure or damage.
 Note	This represents an important piece of information that needs your attention.
 Tip	This represents a useful tip that might make it easier, better or faster to perform a task.
 Remember	This is a reminder of something important that relates to the information you are reading.

1.4 Feedback

Arm welcomes feedback on this product and its documentation.

1.4.1 Feedback on this product

If you have any comments or suggestions about this product, contact your supplier and give:

- The product name.
- The product revision or version.
- An explanation with as much information as you can provide. Include symptoms and diagnostic procedures if appropriate.

1.4.2 Feedback on content

If you have comments on content, send an email to errata@arm.com and give:

- The title Introduction to SVE.
- The number 102476_0001.
- If applicable, the page number(s) to which your comments refer.
- A concise explanation of your comments.

Arm also welcomes general suggestions for additions and improvements.



Arm tests the PDF only in Adobe Acrobat and Acrobat Reader and cannot guarantee the quality of the represented document when used with any other PDF reader.

2 Overview

This guide is a short introduction to the Scalable Vector Extension (SVE) for the Arm AArch64 architecture. In this guide, you can learn about the concept and main features of SVE, the application domains of SVE, and how SVE compares to Neon. We also describe how to develop a program for an SVE-enabled target.

2.1 Before you begin

This article assumes you are already familiar with the following concepts:

- Single Instruction Multi Data (SIMD)
- Neon

If you are not familiar with these concepts, read:

- [Introducing Neon for Armv8-A](#)

3 Introducing SVE

This section introduces the Scalable Vector Extension (SVE) of the Arm AArch64 architecture.

Following the development of the Neon architecture extension, which has a fixed 128-bit vector length for the instruction set, Arm designed the Scalable Vector Extension (SVE) as a next-generation SIMD extension to AArch64. SVE allows flexible vector length implementations with a range of possible values in CPU implementations. The vector length can vary from a minimum of 128 bits up to a maximum of 2048 bits, at 128-bit increments. The SVE design guarantees that the same application can run on different implementations that support SVE, without the need to recompile the code. SVE improves the suitability of the architecture for High Performance Computing (HPC) and Machine Learning (ML) applications, which require very large quantities of data processing.

SVE introduces the following key features:

- Scalable vectors
- Per-lane predication
- Gather-load and scatter-store
- Speculative vectorization
- Horizontal and serialized vector operations

These features help vectorize and optimize loops when you process large datasets.

SVE is not an extension nor the replacement of the Neon instruction set. SVE is redesigned for better data parallelism for HPC and ML.



The [SVE architecture supplement](#) is available.

4 SVE architecture fundamentals

This section introduces the basic architecture features of SVE.

SVE is based on a set of scalable vectors. SVE adds the following registers:

- 32 scalable vector registers, Z0–Z31
- 16 scalable predicate registers, P0–P15
- One First Fault predicate Register (FFR)
- Scalable vector system control registers ZCR_E1x

Let us look at each of these registers in turn.

4.1 Scalable vector registers z0–z31

The scalable vector registers Z0–Z31 can be implemented with 128–2048 bits in microarchitectures. The bottom 128 bits are shared with the fixed 128-bit v0–v31 vectors of Neon.

The figure below shows the scalable vector registers Z0–Z31:

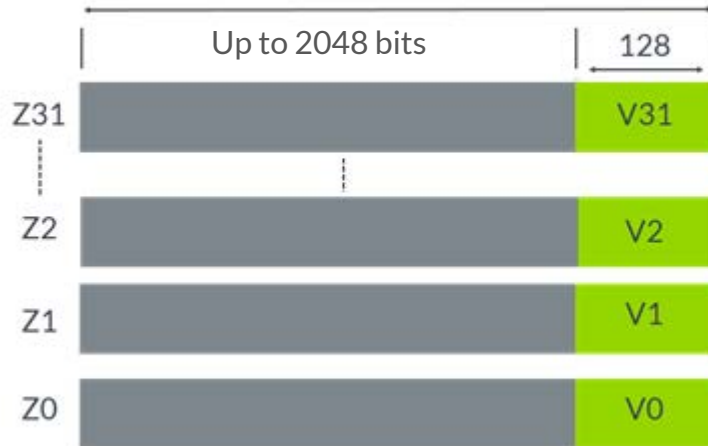

Figure 1 Scalable vector registers z0–z31

The scalable vectors:

- Can hold 64, 32, 16, and 8-bit elements
- Support integer, double-precision, single-precision, and half-precision floating-point elements
- Are configurable with the vector length for each Exception Level (EL)

4.2 Scalable predicate registers P0–P15

To govern which active elements are involved in the operations, the predicate registers are used in many SVE instructions as masks, which also gives flexibility to the vector operation. The figure below shows the scalable predicate registers P0–P15:



Figure 2 Scalable predicate registers P0–P15

The predicate registers are usually used as bit masks for data operations, where:

- Each predicate register is 1/8 of the Zx length.
- P0–P7 are governing predicates for load, store, and arithmetic.
- P8–P15 are extra predicates for loop management.
- First Fault Register (FFR) is a special predicate register, which is set by the first-fault load and store instructions, to indicate how successful the load and store operation for each element is. FFR is designed to support speculative memory accesses which make the vectorization, in many situations, easier and safer.

The predicate registers can also be used as operands in various SVE instructions.

4.3 Configurable vector length

Within the maximum implemented vector length, it is also possible to configure the length of the vector for each Exception level through the ZCR_E1x registers. The length implementation and configuration need to meet the minimum requirements from the [AArch64 SVE Supplement](#), so that either of the following conditions are met:

- An implementation must allow the vector length to be constrained to any power of two.
- An implementation allows the vector length to be constrained to multiples of 128 that are not a power of two.

Privileged Exception levels can use the **LEN** fields of the scalable vector control registers ZCR_E11 , ZCR_E12 , and ZCR_E13 to constrain the vector length at that Exception level and at less privileged Exception levels:



Figure 3 Scalable vector system control registers ZCR_E1x

The scalable vector system control registers indicate the SVE implementation features:

- The ZCR_E1x.LEN field is for the vector length of the current and lower exception levels.
- Most bits are currently reserved for future use.

4.4 SVE assembly syntax

SVE assembly syntax format is composed of operation code, destination register, predicate register (if the instruction supports predicate masks), and input operators. The following instruction examples show the detail of this format.

Example 1:

```
LDFFD { <Zt> .D }, <Pg> / Z, [ <Xn | SP >, <Zm> .D, LSL #3 ]
```

Where:

- <Zt> are the vectors, Z0–Z31
- <Zt> .D and <Zm> .D specify the element types of the destination and operand vectors and do not need to specify the element numbers
- <Pg> are the predicates, P0–P15
- <Pg> / Z is the zeroing predication
- <Zm> specifies the offset of the address mode for the gather-load

Example 2:

```
ADD <Zdn> .<T>, <Pg> / M, <Zdn> .<T>, <Zm> .<T>
```

Where:

- M is the merging predication
- <Zdn> is both the destination register and one of the input operators. The instruction syntax shows <Zdn> at both places for your convenience. In assembly encoding, they are encoded once, for simplification.

Example 3

```
ORRS <Pd> .B, <Pg> .Z, <Pn> .B, <Pm> .B
```

Where:

- **S** is a new interpretation of predicate condition flags **NZCV**
- **<Pg>** a governing predicate acts a “bit mask” in the example operation.

4.5 SVE architecture features

SVE includes the following key architecture features:

- Per-lane predication

To allow flexible operations on selected elements, SVE introduces 16 governing predicate registers, **P0–P15**, to indicate the valid operation on active lanes of the vectors. For example:

```
ADD Z0.D, P0/M, Z1.D, Z2.D // Add the active elements Z1 and Z2 and put the result
in Z0. P0 indicates which elements of the operands are active and inactive. 'M'
after P0 refers to Merging, which indicates that the inactive element will be
merged and as a result Z0 inactive element will remain its original value after the
ADD operation. If it was 'Z' after P0, which refers to Zeroing, then the inactive
element of the destination register will be zeroed after the operation.
```

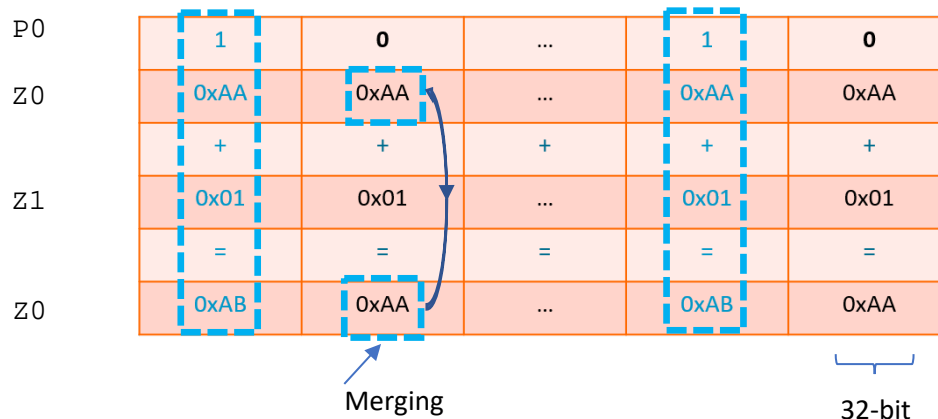

Figure 4 Per-lane predication merging

If the predicate specification is '**/Z**', then the operation does zeroing to the results of the corresponding elements of the destination vector, where the predicate elements are zero. For example:

```
CPY Z0.B, P0/Z, #0xFF //Copy a signed integer 0xFF into Z0, where the inactive
elements of Z0.B will be set to zero.
```

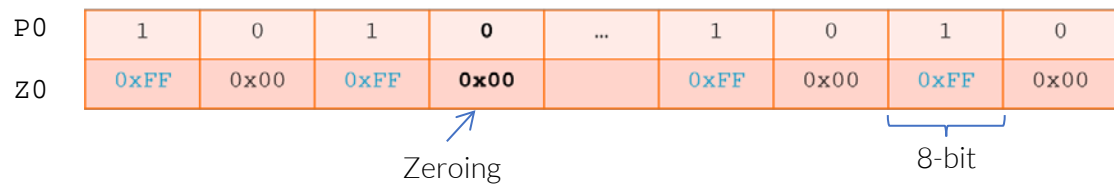

Figure 5 Per-lane predication zeroing



Not all instructions have predicate options. Also, not all predicate operations have both merging and zeroing options. You must refer to the [SVE Architecture Supplement](#) for the specification details of each instruction.

- Gather-load and scatter-store

The address mode in SVE allows the vector to be used as the base address and the offset in the Gather-load and Scatter-store instructions, which enables non-contiguous memory locations. For example:

```
LD1SB Z0.S, P0/Z, [Z1.S] // Gather load of signed bytes to active 32-bit
                           elements of Z0 from memory addresses generated by 32-bit vector base Z1.
LD1SB Z0.D, P0/Z, [X0, Z1.D] // Gather load of signed bytes to active elements of
                              Z0 from memory addresses generated by a 64-bit scalar base X0 plus vector index in
                              Z1.D.
```

The following example shows the loading operation of `LD1SB Z0.S, P0/Z, [Z1.S]`, where `P0` contains all true element and `Z1` contains scattered addresses. After loading, the bottom byte of each `Z0.S` is updated with the fetched data from the scattered memory location.

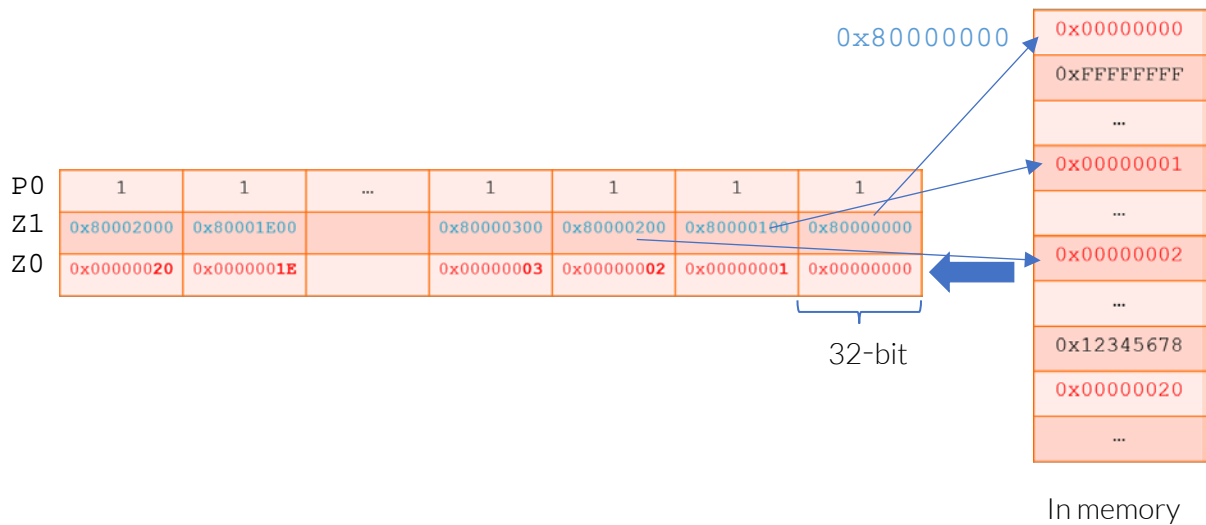

Figure 6 Gather-load and scatter-store example

- Predicate-driven loop control and management

As a key feature of SVE, predication does not only give the flexibility of controlling individual elements of the vector operation, but also enables the predicate-driven loop control. Predicate-driven loop control and management make the loop control efficient and flexible. This feature removes the overhead of processing the extra loop heads and tails of partial vectors, by registering the active and inactive elements index in the predicate registers. Predicate-driven loop control and management means that, in the following loop iteration, only the active elements do the expected options. For example:

```
WHILELO P0.S, x8, x9 // Generate a predicate in P0 that starting from the lowest
numbered element is true while the incrementing value of the first, unsigned scalar
X8 operand is lower than the second scalar operand X9 and false thereafter, up to
the highest numbered element.

B.FIRST Loop_start // B.FIRST (equivalent to B.MI) or B.NFRST (equivalent to B.PL)
are often used to branch based on the above instruction test results of whether the
first element of P0 is true or false as an ending or continue condition of a loop.
```



Figure 7 Predicate-driven loop control and management example

- Vector partitioning for software-managed speculation

Speculative loads can cause challenges to the memory read of a traditional vector, where if any fault occurs in some elements during the read, it is difficult to reverse the load operation and track which elements failed the loading. Neon does not allow speculative load. To allow speculative loads to vectors, for example **LDRFF**, SVE introduces the first-fault vector load instructions. To allow vector accesses to cross into invalid pages, SVE also introduces the First-Fault predicate Registers (FFRs). When loading to an SVE vector with first-fault vector load instructions, the FFR register updates with the load success or fail result for each element. When a load fault occurs, FFR immediately registers the corresponding element, registers the rest of the elements as 0 or false, and does not trigger an exception. Commonly, **RDFFR** instructions are used to read the FFR status. When the first element is false, **RDFFR** instructions finish the iterations. If the first element is true, **RDFFR** instructions continue the iterations. The length of FFR is the same as a predicate vector. The value can be initialized with **SETFFR** instruction. The following example uses **LDRFF1D** to read from memory, and the FFR updates correspondingly:

```
LDRFF1D Z0.D, P0/Z, [Z1.D, #0] // Gather load with first-faulting behaviour of
doublewords to active elements of Z0 from memory addresses generated by the vector
base Z1 plus 0. Inactive elements will not read Device memory or signal faults and
are set to zero in the destination vector. Successful loads from the valid memory
will set true to the elements in FFR. The first-faulting load will set false or 0
to the corresponding element and the rest of the elements in FFR.
```

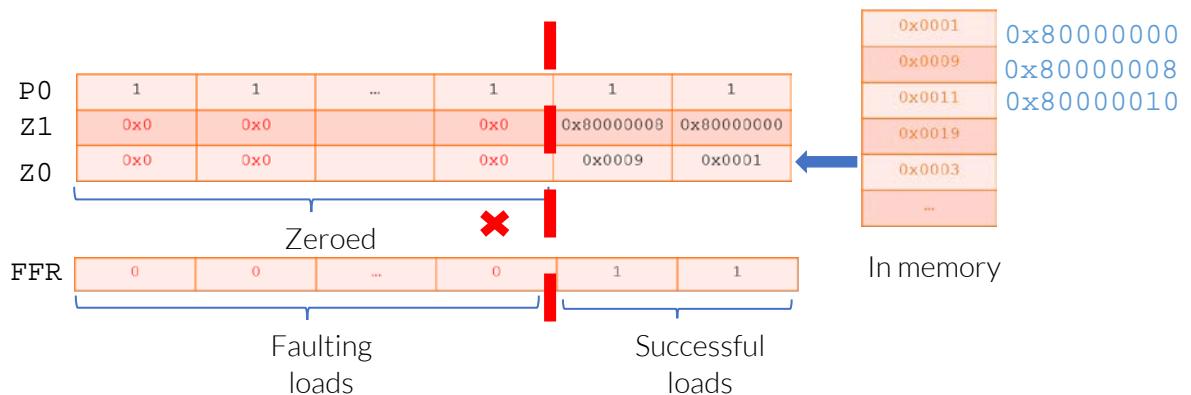

Figure 8 Vector partitioning for software-managed speculation example

- Extended floating-point and horizontal reductions

To allow efficient reduction operations in a vector, and meet different requirements to the accuracy, SVE enhances floating-point and horizontal reduction operations. The instructions might have in-order (low to high) or tree-based (pairwise) floating-point reduction ordering, where the operation ordering might result in different rounding results. These operations trade-off repeatability and performance. For example:

```
FADDA D0, P0/M, D1, Z2.D // Floating-point add strictly-ordered reduction from
low to high elements of the vector source, accumulating the result in a SIMD&FP
```

scalar register. The example instruction adds D1 and all active elements of Z2.D and place the result in scalar register D0. Vector elements are process strictly in order from low to high, with the scalar source D1 providing the initial value. Inactive elements in the source vector are ignored. Whereas FADDV would perform a recursive pairwise reduction, and put the result in a scalar register.

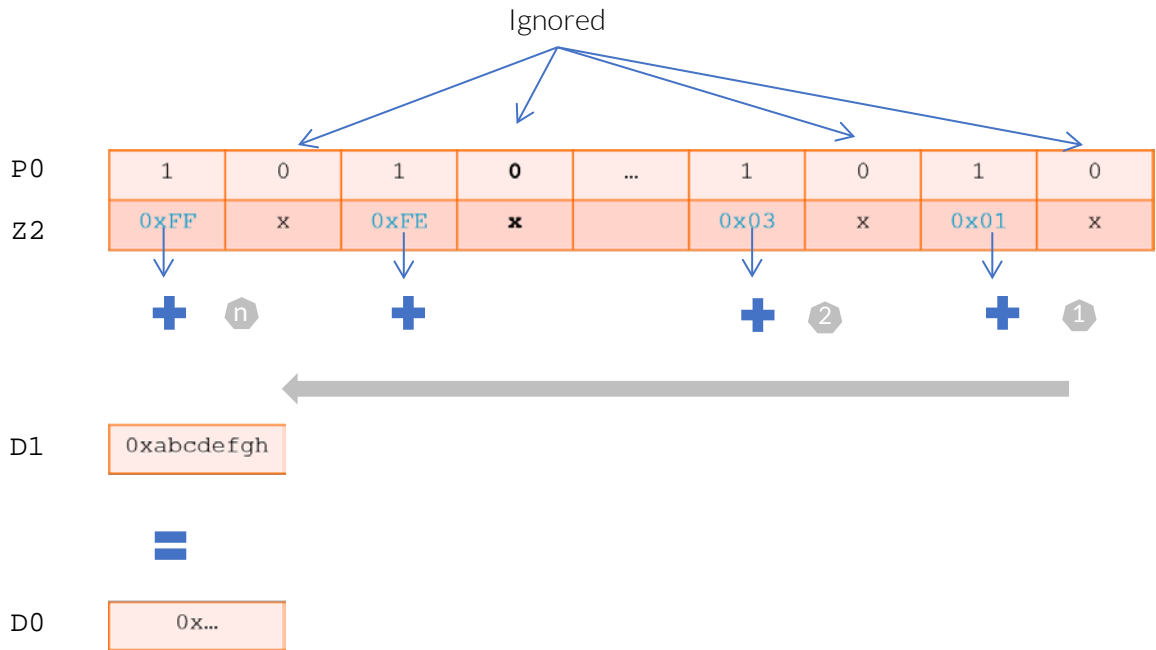

Figure 9 Extended floating-point and horizontal reductions example

5 Programming with SVE

This section describes the software tools and libraries that support SVE application development. This section also describes how to develop your application for an SVE-enabled target and run it on SVE-enabled hardware, and describes how to run your application under SVE emulation on any Armv8-A-based hardware.

5.1 Software and libraries support

To build an SVE application, you must choose a compiler that supports SVE features, such as:

- Version 8.0+ of the GNU tools support SVE optimization for C/C++/Fortran.
- [Arm Compiler for Linux](#), a native compiler for Arm Linux. Arm Compiler for Linux versions 18.0+ supports SVE code generation for C, C++, and Fortran code. Arm Compiler for Linux is part of the Arm Linux user-space tooling solution [Arm Alinea Studio](#).
- [Arm Compiler 6](#), a cross platform compiler for bare-metal application development, also supports SVE code generation from version 6.12.

In addition to the compilers, you can also rely on some highly-optimized SVE libraries, such as:

- [Arm Performance Libraries](#), a set of highly optimized math routines, can be linked to your application. Arm Performance Libraries versions 19.3+ support math libraries for SVE. Arm Performance Libraries is part of Arm Compiler for Linux.
- Other third-party math libraries.

5.2 How to program for SVE

There are a few ways to write or generate SVE code. In this section of the guide, we explore four methods of programming for SVE:

- Write SVE assembly code
- Program with SVE intrinsics
- Auto-vectorization
- Using SVE optimized libraries

Let us look at these four options in more detail.

5.2.1 Write assembly

You can write SVE instructions as inline assembly in your C/C++ code or as a complete function in assembler source. For example:

```

        .globl subtract_arrays          // -- Begin function
        .p2align          2
        .type subtract_arrays,@function
subtract_arrays:                          // @subtract_arrays
        .cfi_startproc
// %bb.0:
        orr    w9, wzr, #0x400
        mov    x8, xzr
        whilelo p0.s, xzr, x9
.LBB0_1:                                  // =>This Inner Loop Header: Depth=1
        ld1w   { z0.s }, p0/z, [x1, x8, lsl #2]
        ld1w   { z1.s }, p0/z, [x2, x8, lsl #2]
        sub    z0.s, z0.s, z1.s
        st1w   { z0.s }, p0, [x0, x8, lsl #2]
        incw   x8
        whilelo p0.s, x8, x9
        b.mi   .LBB0_1
// %bb.2:
        ret
.Lfunc_end0:
        .size subtract_arrays, .Lfunc_end0-subtract_arrays
        .cfi_endproc T

```

If you are mixing functions that are written in a high-level language and in assembly, you must be familiar with [Application Binary Interface \(ABI\)](#) standard, as updated for SVE. The [Procedure Call Standard for Arm Architecture \(AAPCS\)](#) specifies the data types and register allocations and is most relevant to programming in assembly. The AAPCS requires that:

- o Z0–Z7 and P0–P3 are used for passing the scalable vector parameters and results.
- o Z8–Z15 and P4–P15 are callee-saved.
- o All the other vector registers (Z16–Z31) are corruptible by the callee function, where the caller function is responsible for backing up and restoring them, when needed.

5.2.2 Use SVE instruction functions (intrinsics)

SVE intrinsics are functions supported by the compilers that can be replaced with corresponding instructions. Programmers can directly call the instruction functions in high-level languages like C and C++. The ACLE (Arm C Language Extension) for SVE defines which SVE instruction functions are available, their parameters and what they do. Compilers which support the ACLE can replace the intrinsics with mapped SVE instructions during the compilation. To use the ACLE intrinsics, you must include the header file “arm_sve.h”, which contains a list of vector types and instruction functions (for SVE) that can be used in C/C++. Each data type describes the size and datatype of the elements in the vector:

- o `svint8_t svuint8_t`
- o `svint16_t svuint16_t svfloat16_t`
- o `svint32_t svuint32_t svfloat32_t`
- o `svint64_t svuint64_t svfloat64_t`

For example, `svint64_t` represents a vector of 64-bit signed integers, and `svfloat16_t` represents a vector of half-precision floating-point numbers.

The following example C code has been manually optimized with SVE intrinsics:

```
//intrinsic_example.c
#include <arm_sve.h>
svuint64_t uaddlb_array(svuint32_t Zs1, svuint32_t Zs2)
{
    // widening add of even elements
    svuint64_t result = svaddlb(Zs1, Zs2);
    return result;
}
```

Source code, which includes `arm_sve.h`, can use the SVE vector types in the same way data types can be used for variable declaration and function parameters. To compile the code using Arm C/C++ Compiler, and target the Armv8-A architecture that supports SVE, use:

```
armclang -O3 -S -march=armv8-a+sve -o intrinsic_example.s intrinsic_example.c
```

This command generates the following assembly code:

```
//intrinsic_example.s
uaddlb_array:                                // @uaddlb_array
    .cfi_startproc
// %bb.0:
    uaddlb    z0.d, z0.s, z1.s
    ret
```



This example uses Arm Compiler for Linux 20.0.

5.2.3 Auto-vectorization

C/C++/Fortran compilers, for example the native [Arm Compiler for Linux](#) and GNU compilers for Arm platforms, support vectorizing C, C++, and Fortran loops using SVE instructions. To generate SVE code, select the appropriate compiler options. For example, when `armclang` uses the `-march=armv8-a+sve` option, the `armclang` also uses the default options `-fvectorize` and `-O2`. If you want to use the SVE-enabled version of the libraries, combine `-march=armv8-a+sve` with `-armpl=sve`. For more information about the compiler optimization options, refer to the compiler developer and reference guides, or the compiler man pages.

5.2.4 Use optimized libraries

Use libraries that are highly-optimized for SVE, for example [Arm Performance Libraries](#) and [Arm Compute Libraries](#). Arm Performance Libraries contain highly-optimized implementations for BLAS, LAPACK, FFT, sparse linear algebra, and libamath-optimized mathematical functions. To be able to link any of the Arm Performance Libraries functions, you must install Arm Allinea Studio and include `armpl.h` in your code. To build the application with Arm Compiler for Linux and Arm Performance

Libraries, you must specify `-armpl=<arg>` on the command line. If you use the GNU tools, you must include the Arm Performance Libraries installation path in the linker command line with `-L<armpl_install_dir>/lib`, and specify the GNU-equivalent to the Arm Compiler for Linux `-armpl=<arg>` option, which is `-larmpl_lp64`. For more information, please reference to the [Arm Performance Libraries Get started guide](#).

5.3 How to run an SVE application

If you do not have access to SVE hardware, you can use models or emulators to run your code. There are a few models and emulators to choose from:

- QEMU: Cross and native models, which support modeling on Arm AArch64 platforms with SVE.
- Fast Models: Cross platform models, which support modeling Arm AArch64 platforms with SVE, running on x86-based hosts.
- Arm Instruction Emulator (ArmIE): Native AArch64 emulator, which supports the emulation of SVE instructions, and other new instructions, for future architectures.

6 Check your knowledge

- Which scalable vectors are introduced in SVE?

SVE introduces **Z0–Z31** vectors, **P0–P15** predicate registers, and an FFR predicate register.

- How many bits can SVE vectors have?

Z0–Z31 can be implemented from 128 bits up to 2048 bits wide. The length can be either a power of 2 number or a multiplication of 128.

- What are the advantages of SVE compared to a traditional SIMD instruction set, for example Neon?

The advantages of SVE, compared to Neon, include:

- SVE programs can be vector-length agnostic; a single binary works on machines with different hardware vector lengths.
- SVE has more vectorization flexibility.
- SVE is designed for HPC and ML. Compared to Neon-based targets, SVE enables application performance advantages, even when the SVE-enabled targets use the same vector length (128-bit) as Neon targets.

7 Related information

Here are some resources that relate to the content in this guide:

- [Arm architecture exploration tools](#)
- [Arm Architecture Reference Manual Supplement – The Scalable Vector Extension \(SVE\) for Armv8-A](#)
- [ACLE \(Arm C Language Extensions \(ACLE\) for SVE](#)
- [Arm® A64 Instruction Set Architecture: Future Architecture Technologies in the A architecture profile](#)
- [The Procedure Call Standard for Arm Architecture \(AAPCS\)](#)
- [Vector Function Application Binary Interface Specification for AArch64](#)
- [Server and HPC Linux user space software tooling: Arm Compiler for Linux, Arm Performance Libraries](#)
- [Arm Instruction Emulator \(ArmIE\)](#)
- [SVE Programmer’s Guide](#)
- [Arm SVE intrinsics coding considerations](#)
- [SVE and Neon coding compared](#)
- [Arm Community](#) – Ask development questions and find articles and blogs on specific topics from Arm experts.
- [Arm Compiler 6 for bare-metal images](#)
- [Fast Models](#)
- [Neon resources](#)
- [QEMU](#)

Appendix A Revisions

This appendix describes the technical changes between released issues of this document.

Table 0-1 Issue 00

Change	Location	Affects
First release	All	All